

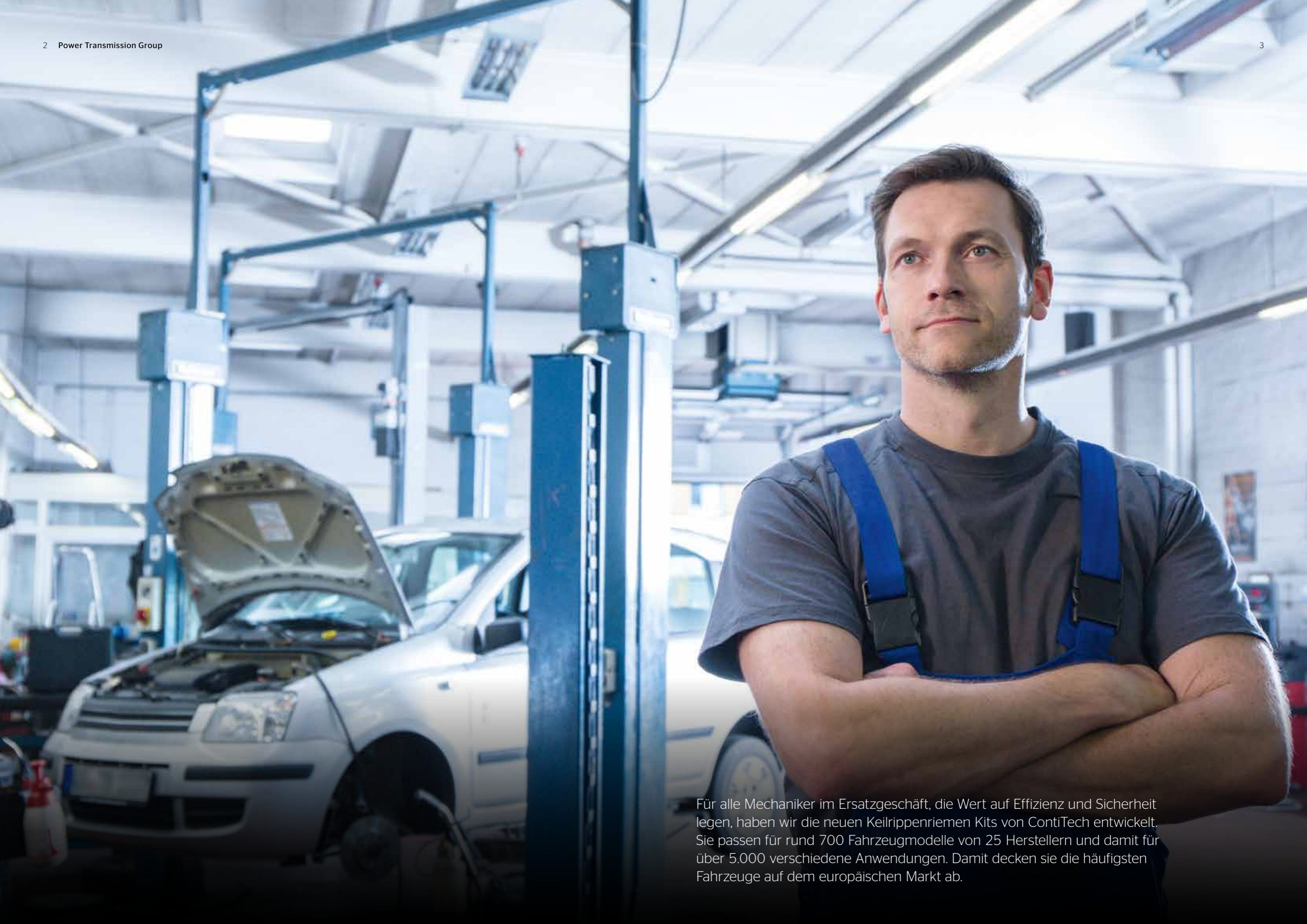

# Alles aus einer Hand:

## Das Keilrippenriemen Kit





Für alle Mechaniker im Ersatzgeschäft, die Wert auf Effizienz und Sicherheit legen, haben wir die neuen Keilrippenriemen Kits von ContiTech entwickelt. Sie passen für rund 700 Fahrzeugmodelle von 25 Herstellern und damit für über 5.000 verschiedene Anwendungen. Damit decken sie die häufigsten Fahrzeuge auf dem europäischen Markt ab.





#### Erweiterte Inhalte (Augmented Reality)

Grafiken mit diesem Symbol bieten zusätzliche Inhalte wie 3D-Darstellungen oder Animationen, die mit einem Smartphone oder Tablet angezeigt werden können. Installieren Sie sich einfach die kostenlose ContiDrive App oder die Junaio App und scannen Sie die entsprechende Grafik ein um die erweiterten Inhalte abzurufen.

Verfügbar für iOS und Android.

# Volle Kontrolle über die Spannung: Keilrippenriemen Kit

Nur wenn die Riemenspannung stimmt, kann der getauschte Keilrippenriemen dauerhaft einwandfrei laufen. Daher ist es sinnvoll, alle Verschleißteile des Riemenantriebes wie zum Beispiel Spann- und Umlenkrollen oder Dämpfer bei jedem Riemenwechsel mit zu tauschen.

Mit dem Keilrippenriemen Kit von ContiTech haben Monteure sofort alle benötigten Teile zur Hand – optimal aufeinander abgestimmt und sofort einsatzbereit. Das macht den Riemenwechsel einfacher und schneller. Außerdem: Weil alle Teile aus einer Hand kommen, gibt es auch für alle Servicefragen nur einen

Ansprechpartner. Das erhöht die Wirtschaftlichkeit und Effizienz in der Werkstatt. Darüber hinaus bauen Werkstätten mit ContiTech Teile in der Qualität der Erstausrüstung ein.

Worauf Sie sich verlassen können, das weiß auch Ihr Kunde zu schätzen: Keilrippenriemen von ContiTech werden in der Regel nicht geschliffen, sondern im Formverfahren hergestellt. Das sorgt für optimale Maßhaltigkeit, hohe Lebensdauer und Laufruhe.

Die Qualität der Komponenten zeigt sich auch im Detail, zum Beispiel an den

verwendeten Rillenkugellagern. Diese Langlauflager sind mit einem vergrößerten Fettvorratsvolumen ausgestattet und aufgrund der hohen Tragzahlen hoch belastbar. Deshalb arbeiten sie besonders zuverlässig und geräuscharm.

#### Inhalt

- > Keilrippenriemen
- > Spann- und Umlenkrollen
- > Spanndämpfer
- > Befestigungsmaterial

#### Vorteile

- > Exakte Fahrzeugzuordnung
- > Aufeinander abgestimmte Komponenten
- > Originalqualität

#### Grundplatte (Montageflansch)

aus Aluminiumdruckguss

#### Gleitlager

ermöglicht die Drehung des Spannarms

#### Reibbelag

mit Reibring aus Stahl (außen)

#### Drehfeder

erzeugt die Vorspannung

#### Spannrolle

mit einreihigem Lager

#### Spannarm

aus Aluminiumdruckguss

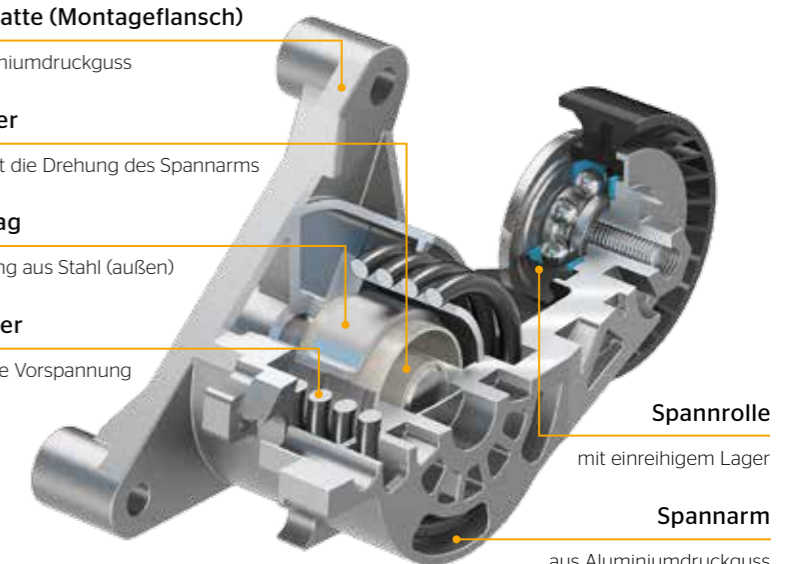

# Produktprogramm

## Keilrippenriemen Kits



4PK		
4PK735K1	Ford Mondeo / Transit 2.0-2.2 Di, TDCi, TDDi; Jaguar X-Type 2.0-2.2 D	2000-2009
4PK855K1	Audi A4 / A6; VW Passat; Škoda Superb 1.6, 1.8 (T), 1.9 TDI, 2.0 (TDI)	1994-2008
4PK890K1	BMW 3 316 i, g, 318 i, is, g, ti / 5 518 i, g / Z3 1.8, 1.9	1991-2003
4PK925K1	Dacia Logan / Sandero; Renault Clio / Kangoo / Thalia / Twingo 1.2 (LPG) (16 V)	1997-2008
5PK		
5PK940K1	Opel Astra G, H / Combo / Corsa / Meriva / Vectra C / Zafira A, B 1.6 (16 V) (CNG), 1.8 (16 V)	1998-
5PK1110K1	Dacia Dokker / Lodgy / Logan; Renault Clio II, Kangoo, Laguna, Logan Megane I / Thalia 1.4 (16 V), 1.6 (16 V)	1997-
5PK1125K1	Nissan Primastar dCi, 2.0; Opel Vivaro 1.9 Di, DTI, 2.0 16V, ECOTEC; Renault Laguna / Trafic 1.9 dCi, 2.0 (16 V)	2000-2006
5PK1145K1	Rover 25 / 45 / 200 / 400 1.4-1.8 (16 V); Fiat Bravo / Doblo / Punto 1.2 (LPG), 1.4 (Natural Power) (16 V); Lancia Ypsilon 1.2, 1.4	2003-2012
5PK1150K1	Alfa Giulietta / Mito 1.4 (TB) (16 V); Fiat 500 / Panda / Punto / Doblo 1.2 (LPG) 1.4 (Natural Power) (16 V)	2003-
5PK1200K1	Nissan Almera / Micra / Kubistar 1.5 dCi; Renault Clio / Kangoo / Megane / Modus / Scénic 1.4 (16 V), 1.6 (16 V), 1.5 dCi	2000-
5PK1212K1	Opel Astra G, H / Combo / Corsa / Meriva / Tigra / Zafira A, B 1.6 (16 V) (CNG), 1.8 (16 V)	1998-
5PK1300K1	Audi A4 / A6; Škoda Superb; VW Passat 1.6, 1.8 (T), 1.9 TDI, 2.0 (TDI)	1994-2008
5PK1135K1	Nissan Kubistar / Micra / Clio II / Clio III / Kangoo / Megane II / Thalia 1.4 (16 V), 1.5 dCi, 1.6 (16 V)	2001-
5PK1432K1	Audi A4 / A6; Škoda Superb; VW Golf / Passat 1.9/2.0 TDI	1998-2008
5PK1592K1	Audi A4 / A6; VW Passat 1.9 TDI	1995-2001
5PK1750K1	Dacia Logan / Sandero; Renault Clio / Kangoo / Laguna / Megane / Scénic 1.4-2.0 (16 V)	1996-
6PK / 6DPK		
6PK800K1	Citroën C1 / C2 / C3 / C4; Ford Fiesta V / Fiesta VI / Focus II; Volvo C30 / S40 / V50 / V70 1.4 HDi, 1.4 (16 V), 1.6 D, 1.6 Hdi, 1.6 TDCi	2002-
6PK905 EXTRA K1	Citroën Berlingo / C3 / C4 / C5 / DS3 / DS4 / DS5; Mini Mini; Peugeot 2008 / 207 / 208 / 3008 / 308 1.4 (LPG) (16 V), 1.6 (Vti) (THP) (16 V) (GTI)	2006-
6PK906K1	Audi A3; Seat Cordoba / Ibiza / Inca / Leon / Toledo; Škoda Octavia; VW Bora / Caddy / Golf / New Beetle / Polo 1.9 TDI, SDI	1995-2006
6PK906K3	Audi A3; Seat Cordoba / Ibiza / Leon / Toledo; Škoda Octavia; VW Bora / Golf / Polo 1.9 D, TDI, SDI	1993-2006
6PK976K1	Citroën Berlingo / C3 / C4 / C5 / DS3 / DS4; Peugeot 1007 / 2008 / 206 (+) / 207 / 208 / 3008 / 308 / 407 / 5008 / 508 / Partner 1.4/1.6 16 V, HDi	2002-
6PK976K3	Seat Cordoba / Ibiza; VW Corrado / Golf / Passat / Sharan / Vento 1.6, 1.8 (i) (16 V), 2.0 (i)	1988-2002
6PK995K1	Audi A2; Seat Cordoba / Ibiza / Fabia / Roomster; VW Fox / Lupo / Polo 1.2/1.4 TDI	1999-
6PK1020 EXTRA K1	Citroën Berlingo / C3 / C4 / C5 / DS3 / DS4 / DS5; Peugeot 208 / 308 / 508 / 2008 / 3008 / 5008 1.4 HDi, 1.6 HDi	2009-
6PK1045K1	Seat Cordoba / Ibiza; VW Caddy / Golf / Passat / Polo / Transporter / Vento 1.9 D, TD, TDI, GTD, SDI	1990-2003
6PK1045K2	Audi A3; Seat Altea / Leon / Toledo; Škoda Octavia; VW Caddy / Golf / Passat / Touran / Jetta 1.6/2.0 FSI	2003-
6PK1045K3	Citroën Berlingo / Jumpy / Xsara; Peugeot 306 / Expert / Partner 1.9 D	1996-
6PK1050K1	Audi A3; Seat Altea / Leon / Toledo; Škoda Octavia / Superb; VW Caddy / Golf / Passat / Touran / Jetta 1.9 TDI, 2.0 TDI, SDI	1995-
6PK1050K2	Audi A3; Seat Altea / Leon / Toledo; Škoda Octavia / Superb; VW Caddy / Golf / Passat / Touran / Jetta 1.9 TDI, 2.0 TDI, 16 V	2003-



6PK1050K3	Citroën C2 / C3 / C4; Peugeot 1007 / 207 / 307 1.1, 1.4 (i) (16 V) 1.6 (VTS) (16 V)	2000-
6PK1070K1	Audi A1 / A(Q)3; Seat Altea / Ibiza; Škoda Fabia / Octavia / Superb; VW Caddy / Golf / Passat / Sharan / Tiguan / Touran 1.2/1.6/2.0 TDI	2003-
6PK1070K2	Seat Arosa / Cordoba / Ibiza / Inca; Škoda Felicia; VW Caddy / Golf / Lupo / Polo / Vento 1.0 (i), 1.4 (i) (16 V), 1.6 (i) (GLX)	1991-2005
6PK1070K3	Citroën C2 / C3 / C4; Peugeot 1007 / 207 / 307 / 308 1.4 16 V, 1.6 (BioFlex) (16 V)	2000-
6PK1080K1	Audi A2; Seat Cordoba / Ibiza / Leon; Škoda Fabia / Felicia / Octavia; VW Bora / Caddy / Golf / Polo 1.4 (16 V) (FSI), 1.6 (FSI) (16 V) (GLX)	1995-
6PK1080K2	Citroën Berlingo / Evasion / Xantia / Xsara / ZX; Fiat Ulysse; Peugeot 306 / 405 / 406 / 806 / Expert 1.8 (i) (16 V), 2.0 (i) (16 V) (Turbo)	1991-
6PK1100K1	Seat Altea / Ibiza / Leon / Toledo; Škoda Octavia; VW Caddy / Golf 1.4 (16 V), 1.6 (i)	1993-
6PK1125K1	Citroën C2 / C3; Peugeot 307 1.1 (i), 1.4 (i) (16 V), 1.6 (16 V)	2000-
6PK1130K1	Dacia Sandero; Renault Clio / Kangoo / Grand Kangoo / Kangoo Be Bop / Megane II / Twingo II / Wind 1.4 (16 V), 1.5 dCi, 1.6 (16 V), 1.6 RS	2001-
6PK1145K1	Ford Galaxy; Seat Alhambra / Cordoba / Ibiza / Inca / Toledo; VW Caddy / Golf / Passat / Polo / Sharan / Vento 1.9 D, TD, TDI, SDI	1991-2004
6PK1145K2	Citroën Jumper; ZX; Fiat Ducato; Peugeot 306 / 405 / Boxer; Suzuki Vitara 1.8 D, 1.9 D, TD, DT	1991-2002
6PK1145K4	Peugeot 307 1.4 (16 V), 1.6 (16 V)	2000-
6PK1153K1	Seat Alhambra / Cordoba / Ibiza / Toledo; VW Caddy / Golf / Passat / Polo / Vento / Sharan 1.6 (i), 1.8, 2.0 (i) (16 V)	1990-2002
6PK1153K2	Peugeot 307 2.0 HDI	2000-
6PK1180K1	Alfa Mito 1.3 JTDM; Fiat Punto 1.3 D; Opel Agila / Astra / Combo / Corsa / Meriva; Suzuki Ignis / Splash / Swift / 1.3 CDTI (16 V), DDiS	2003-
6PK1180K2	Seat Cordoba / Ibiza; Škoda Fabia / Roomster; VW Polo 1.4 TDI, 1.9 TDI	2000-
6PK1180K3	Alfa Mito 1.3 JTDM; Fiat 500 / Doblo / Fiorino / Idea / Panda / Punto; Lancia Musa / Ypsilon; Opel Agila 1.3 JTD, D Multijet, CDTI	2003-
6DPK1195K1	Audi A3 / TT; Seat Cordoba / Leon; Škoda Octavia; VW Bora / Golf / New Beetle / Transporter 1.6 (i), 1.8 (T), 2.0	1995-2010
6DPK1195K2	Audi A3; Ford Galaxy; Seat Alhambra / Leon; Škoda Octavia; VW Bora / Golf / Sharan / Multivan / Transporter 1.9 TDI	1995-2010
6PK1200K1	Dacia Duster / Logan / Sandero; Nissan Kubistar / NV200; Renault Clio / (Grand) Scénic / Kangoo / Megane / Modus 1.5 dCi, 1.6 16 V	2001-
6PK1200K2	Dacia Logan; Renault Clio / (Grand) Scénic / Kangoo / Megane / Modus / Thalia / Twingo; Nissan Micra 1.4, 1.5 dCi, 1.6 16 V	2001-
6PK1217K1	Citroën C4 / C5 / Jumpy; Fiat Scudo / Ulysse; Ford C-Max / Focus / Kuga; Peugeot 307 / 308 / 407 / 508 / Expert 2.0 HDI; Volvo 2.0 D	2003-
6PK1310K1	Fiat 500 / Doblo / Idea / Panda / Punto / Strada; Lancia Musa / Ypsilon 1.3 D Multijet, JTD (16 V)	2003-
6PK1318K2	Alfa Romeo Mito; Fiat Fiorino / Grand Punto / Linea / Punto Evo; Opel Agila / Combo / Corsa 1.3, 1.3 CDTI (16 V), 1.3 D, 1.3 DDiS	2003-
6PK1345K1	Citroën Berlingo / Xsara; Ford Fiesta / Fusion; Peugeot 206 1.4 CD, 1.4 HDi, 1.4 TDCi, 1.6 HDi	2001-
6PK1370K1	Opel Astra H / Zafira B 1.9 CDTI (16 V)	2004-
6PK1390K1	Citroën Berlingo / Jumpy / Xsara; Peugeot 206 / 306 / Expert / Partner 1.9 D	1996-
6PK1440K1	Citroën Berlingo / Jumpy / Xsara; Fiat Scudo; Peugeot 306 / Expert / Partner 1.9 D	1996-
6PK1468K1	Citroën Berlingo / Evasion / Jumpy / Xsara; Fiat Scudo / Ulysse; Peugeot 206 / 306 / 406 / 806 2.0 HDI, 2.0 JTD (16 V)	1999-
6PK1453K1	Citroën Berlingo / Xsara; Peugeot 206 (+) / Partner 1.1 (i), 1.4 (i) (BiFuel) (bivalent), 1.6 i, 16 V	1996-
6PK1453K2	Seat Cordoba / Ibiza / Toledo; Škoda Fabia / Rapid / Roomster; VW Fox, Polo 1.2 (12 V)	2001-
6PK1515K1	Hyundai Elantra / Grandeur / Santa Fe I / Santa Fe II / Sonata V / Tucson; Kia Carens II / Carens III / Sportage 2.0 CRDi, 2.2 CRDi	2001-
6PK1538K1	BMW 3 320 i, 323 i, 325 xi, 328 i, 330 xi, 330 Ci, 320 Ci, 323 Ci, 325 Ci, 325 ti / 5 520 i, 523 i, 525 i, 528 i, 530 i / 7 728 i, iL / Z3 2.0, 2.2, 2.8, 3.0	1995-

# Produktprogramm

## Keilrippenriemen Kits

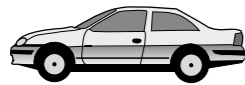

6PK1538K2	BMW 3 320 i, 325 i, 325 xi, 328 i, 330 i, 330 xi, 320 Ci, 323 Ci, 325 Ci, 328 Ci, 330 Ci, 325 ti / 5 520 i, 523 i, 525 i, 528 i, 530 i / 7 728 i, iL / X5 3.0 i	1995-
6PK1548K1	Seat Leon / Toledo; Škoda Octavia; VW Bora / Golf 1.4 16 V, 1.6 (16 V)	1996-2010
6PK1555K1	BMW 3 320 i, 323 i, 328 i, 323 ti, 323 i, 325 i / 5 520 i, 523 i, 525 i, 525 iX, 528 i / 7 728 i, iL / Z3 2.8	1889-2001
6PK1555K2	BMW 3 320 i, 323 i, 328 i, 323 ti, 323 i, 325 i / 5 520 i, 523 i, 525 i, 525 iX, 528 i / 7 728 i, iL / Z3 2.8	1889-2001
6PK1555K3	Ford Escort 1.6 16 V, i, 1.8 16 V	1995-2000
6PK1560K1	Citroën Berlingo / Xsara; Peugeot 206 / Partner 1.1 (i), 1.4 (i) (bivalent), 1.6 (16 V)	1996-
6PK1564K1	Citroën Berlingo / Nemo / Xsara; Fiat Fiorino / Qubo; Peugeot 206 / Bipper / Partner 1.1 (i), 1.4 (i) (bivalent) (BiFuel), 1.6 16 V	1996-
6PK1564K2	Citroën Xsara; Peugeot 206 1.1 (i), 1.4 i, 1.6 (16 V)	1997-
6PK1605K1	Renault Espace III / Megane I / Scenic I 1.9 dCi, 1.9 dTi	1997-2003
6PK1613K1	Audi A4; VW Crafter 1.9 TDI, 2.0 TDI (16 V)	2000-
6PK1642K1	Renault Espace / Laguna / Megane / Scenic 1.9 dTi, 1.9 dCi, 1.9 D, 1.9 dT; Volvo S40 / V40 1.9 DI, TD	1995-2003
6PK1642K2	Ford Mondeo / Transit 2.0-2.2 Di, TDCi, TDDi; Jaguar X-Type 2.0-2.2 D	2000-2009
6PK1660K1	Audi A3; Seat Cordoba / Ibiza / Leon / Toledo; Škoda Octavia; VW Bora / Caddy / Golf / New Beetle / Polo 1.9 TDI, SDI	1995-2010
6PK1660K2	Audi A3; Seat Cordoba / Ibiza / Leon / Toledo; Škoda Octavia; VW Bora / Golf / Polo 1.9 D, TDI, SDI	1993-2010
6PK1660K3	Renault Espace / Laguna / Megane 1.8, 2.0 (i)	1993-2003
6PK1660K4	Citroën Berlingo / Xantia / Xsara / ZX; Peugeot 306 / 406 1.8 16 V, i	1995-
6PK1705K2	Citroën Berlingo / C5 / Xsara; Ford Fiesta / Fusion; Mazda 2; Peugeot 206 / 407 1.4 TDCi, HdI, CD, 1.6 HDi	2001-
6PK1710K1	Citroën Berlingo / C5 / Nemo / Xsara; Peugeot 206 (+) / 407 / Bipper / Partner 1.4 HdI, 1.6 HdI	2001-
6PK1710K2	Citroën C5 I / C5 II / C8 / Jumpy; Fiat Scudo / Ulysse; Peugeot 407 / 607 / 807 / Expert 1.8 (16 V), 2.0 (16 V), 2.2	2000-
6PK1715K1	Ford Focus / Tourneo / Transit 1.8 DI, TDCi	1998-
6PK1725K1	Opel Astra / Calibra / Frontera / Omega / Sintra / Vectra 1.6 (i), 1.8 i, 16 V, 2.0 i, 16 V	1988-
6PK1725K2	Citroën Xsara / Xsara Picasso; Peugeot 206 / 406 1.8 (16 V), 2.0 (16 V), 2.0 (S16), 2.2	1999-
6PK1733K2	BMW 3 316 i, 316 g, 318 i, 318 is, 318 ti / Z3 1.8, 1.9	1993-2000
6PK1733K3	Audi A3; Seat Cordoba / Ibiza; Škoda Fabia / Octavia / Rapid / Roomster; VW Eos / Golf / Passat / Polo / Touran 1.4 FSI 1.6 (16 V) (FSI)	2002-
6PK1733K4	Ford Focus 1.4/1.6 16 V	1998-2004
6PK1740K1	Citroën Berlingo / Jumpy / Xsara; Peugeot 206 / 406 / 807 / Expert / Partner 2.0 HdI (16 V); Fiat Scudo / Ulysse; Lancia Phedra 2.0 JTD (16 V)	1998
6PK1740K2	Citroën Berlingo / Evasion / Jumpy / Xsara / ZX; Fiat Scudo / Ulysse; Peugeot 306 / 406 / 806 / Expert / Partner 1.9 D, DT, TD, 2.1 TD	1991-
6PK1740K3	Citroën Xsara / Peugeot 206 2.0 HDi	1999-
6PK1740K4	Citroën C5 II / C8; Fiat Ulysse; Lancia Phedra; Peugeot 406 / 607 / 807 2.2 HDi, 2.2 JTD	2000-
6PK1750K1	Citroën Berlingo / C5 / Evasion / Jumpy / Xantia; Peugeot 206 / 306 / 406 / 806 / Partner 2.0 HdI, 16 V; Fiat Ulysse; Lancia Zeta 2.0 JTD, 16 V	1998-
6PK1750K2	Renault Clio / Kangoo / Laguna / Megane / Scenic / Thalia 1.4 (16 V), 1.6 (16 V)	1997-
6PK1750K3	Citroën Berlingo / Jumpy / Xsara; Peugeot 306 / 406 / Expert 1.9 D, TD, 2.1 TD	1996-
6PK1780K1	Renault Avantage / Escape III, Laguna II / Vel Satis 2.2 dCi	2000-

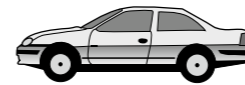
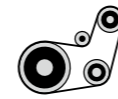

6PK1795K1	Mitsubishi Carisma 1.9 DI-D; Opel Movano / Vivaro 1.9 DTI, DI, 2.0 16 V; Renault Laguna / Trafic; Nissan Primastar 1.8 16 V, 1.9 dCi, 2.0 16 V	2000-
6PK1795K2	Mitsubishi Carisma 1.9 DI-D; Opel Movano / Vivaro 1.9 DTI, DI; Renault Laguna / Master / Trafic 1.9 dCi; Volvo S40 / V40 1.9 DI	1999-
6PK1870K1	BMW 1 116 i, 118 i, 120 i / 3 316 i, 318 i, 320 i, 320 si, 316 Ci, 316 ti, 318 Ci, 318 ti / 5 520 i / X1 18 i / X3 2.0 i / Z4 2.0 i	2000-
6PK1873K1	Seat Cordoba / Ibiza / Toledo; Škoda Fabia / Rapid / Roomster; VW Fox, Polo 1.2 (12 V)	2001-
6PK1873K3	Opel Astra / Zafira 2.0 DI, DTI, DTI 16 V, 2.2 DTI	1998-2005
6PK1873K4	Mercedes C-Klasse / CLK C200/230 Kompressor / E-Klasse E200/230 Kompressor / SLK 200/230 Kompressor	1995-2004
6PK1900K1	Daewoo Leganza / Nubira; Opel Astra / Calibra / Omega / Vectra 1.6 (i), 1.8 i, 16 V, 2.0 i, 16 V	1988-
6PK1950K1	Renault Espace III / Laguna I / Safrane II 2.2 12 V, 2.2 D, 2.2 dT	1993-2002
6PK2080K1	BMW 3 318 d, 320 d, 330 d, 320 Cd, 330 Cd, 318 td, 320 td, 330 xd / 5 520 d, 525 d, 530 d, 530 xd, 535 d, 525 xd, 530 xd / 7 730 d, Ld / X5 3.0 d	2001-
6PK2260K1	Mercedes C-Klasse C200/220 CDI / E-Klasse E200/220/270/280/320 CDI / Sprinter 415 CDI / Viano 2.0/2.2 CDI / Vito 109/111/115 CDI	2001-
6PK2260K2	Mercedes C200 / C220 / C270 / CLK / S320 CDI	1999-2009
6PK2271K1	Mercedes C-Klasse C200 CDI / E-Klasse E200/220/270/320 CDI / M-Klasse ML270 CDI / Viano 2.0/2.2 CDI / Vito 109/111/115 CDI	1998-
6PK2404K1	Audi A4 / A6 / A8 / Allroad; Škoda Superb; VW Passat 2.5 TDI	1997-2006
<b>7PK</b>		
7PK1035K1	Renault Clio / Clio III / Modus / Twingo II / Wind 1.2 (16 V), 1.2 Tce, 1.2 Turbo	2004-
7PK1125K1	Renault (Grand)Scenic / Megane 1.9 dCi, D, 2.0 (Tce) (16 V)	2002-
7PK1795K1	Nissan Interstar; Opel Movano; Renault Master II dCi, 2.5 CDTI, 2.5 dCi	2001-
7PK1970K1	Nissan NV400 / Primstar; Opel Movano B / Vivaro; Renault Laguna / Laguna II / Laguna III / Master III / Traffic II 2.3 dCi, 2.0 CDTI, 2.3 CDTI	2005-



Für alle Mechaniker im Ersatzgeschäft, die Wert auf Effizienz und Sicherheit legen, haben wir die neuen Keilrippenriemen Kits von ContiTech entwickelt. Sie passen für rund 700 Fahrzeugmodelle von 25 Herstellern und damit für über 5.000 verschiedene Anwendungen. Damit decken sie die häufigsten Fahrzeuge auf dem europäischen Markt ab.





Weitere Informationen im PIC.

# Stückliste

## Keilrippenriemen Kits

KIT			
			
<b>4PK</b>			
4PK735K1	4PK735	V85583	
4PK855K1	4PK855	V85533	
4PK890K1	4PK890	V85535	
4PK925K1	4PK925	V85602	
<b>5PK</b>			
5PK940K1	5PK940	V85547	
5PK1110K1	5PK1110	V85704	
5PK1125K1	5PK1125	V85589	
5PK1145K1	5PK1145	V85569	
5PK1150K1	5PK1150	V85569	
5PK1200K1	5PK1200	V85596	
5PK1212K1	5PK1212	V85547	
5PK1300K1	5PK1300	V85543	
5PK1135K1	5PK1135	V85705	V85521
5PK1432K1	5PK1432	V85563	
5PK1592K1	5PK1592	V85571	
5PK1750K1	5PK1750	V85585	V85519
<b>6DPK / 6PK</b>			
6PK800K1	6PK800	V85566	V85505
6PK905 EXTRA K1	6PK906	V85604	
6PK906K1	6PK906	V85545	
6PK906K3	6PK906	V85572	
6PK976K1	6PK976	V85595	
6PK976K3	6PK976	V85541	V85537
6PK995K1	6PK995	V85590	
6PK1020 EXTRA K1	6PK1020 EXTRA	V85714 V85715	
6PK1045K1	6PK1045	V85567	V85537
6PK1045K2	6PK1045	V85542	
6PK1045K3	6PK1045	V85510	
6PK1050K1	6PK1050	V85578	
6PK1050K2	6PK1050	V85579	
6PK1050K3	6PK1050	V85565	
6PK1070K1	6PK1070	V85576	

KIT			
			
6PK1070K2	6PK1070	V85548	
6PK1070K3	6PK1070	V85565	
6PK1080K1	6PK1080	V85548	
6PK1080K2	6PK1080	V85509	
6PK1100K1	6PK1100	V85548	
6PK1125K1	6PK1125		V85561
6PK1130K1	6PK1130	V85596	
6PK1145K1	6PK1145	V85567	V85537
6PK1145K2	6PK1145	V85508	
6PK1145K4	6PK1145		V85561
6PK1153K1	6PK1153	V85541	V85537
6PK1153K2	6PK1153	V85555	V85516
6PK1180K1	6PK1180	V85581	
6PK1180K2	6PK1180	V85576	
6PK1180K3	6PK1180	V85598	
6DPK1195K1	6DPK1195	V85542	
6DPK1195K2	6DPK1195	V85564	
6PK1200K1	6PK1200	V85596	
6PK1200K2	6PK1200	V85596	V85521
6PK1217K1	6PK1217	V85591	
6PK1310K1	6PK1310	V85598	
6PK1318K2	6PK1318	V85581	
6PK1345K1	6PK1345	V85570 V85570	V85700
6PK1370K1	6PK1370	V85599	V85525 V85526
6PK1390K1	6PK1390	V85561	V85500 V85500
6PK1440K1	6PK1440	V85555	V85500 V85504
6PK1468K1	6PK1468	V85573 V85710	V85516
6PK1453K1	6PK1453	V85552	
6PK1453K2	6PK1453	V85603	
6PK1515K1	6PK1515	V85716	V85717
6PK1538K1	6PK1538	V85546	V85534
6PK1538K2	6PK1538	V85607 V85559	V85534

KIT			
			
6PK1548K1	6PK1548	V85562	V85511
6PK1555K1	6PK1555	V85607 V85559	V85534
6PK1555K2	6PK1555	V85546	V85534
6PK1555K3	6PK1555	V85588	V85518
6PK1560K1	6PK1560	V85601	V85520
6PK1564K1	6PK1564	V85601	V85520
6PK1564K2	6PK1564	V85557	V85502
6PK1605K1	6PK1605	V85706	V85507
6PK1613K1	6PK1613	V85576	V85524
6PK1642K1	6PK1642	V85586	V85507
6PK1642K2	6PK1642	V85568	V85514 V85515
6PK1660K1	6PK1660	V85545	V85538
6PK1660K2	6PK1660	V85572	V85538
6PK1660K3	6PK1660		V85506
6PK1660K4	6PK1660	V85553	V85503
6PK1705K2	6PK1705	V85570	V85505
6PK1710K1	6PK1710	V85587	V85528
6PK1710K2	6PK1710	V85712 V85713	
6PK1715K1	6PK1715	V85582	V85513
6PK1725K1	6PK1725	V85544	
6PK1725K2	6PK1725	V85712 V85713	
6PK1733K2	6PK1733	V85549	V85536
6PK1733K3	6PK1733	V85580	V85531
6PK1733K4	6PK1733	V85560	V85518
6PK1740K1	6PK1740	V85551 V85554 V85574	
6PK1740K2	6PK1740	V85551 V85554 V85574	
6PK1740K3	6PK1740	V85573	V85530
6PK1740K4	6PK1740	V85573	V85711
6PK1750K3	6PK1750	V85551 V85554 V85574	

KIT			
			
6PK1750K1	6PK1750	V85573 V85551	
6PK1750K2	6PK1750	V85585	V85519
6PK1780K1	6PK1780	V85584	V85512
6PK1795K1	6PK1795	V85592	V85512
6PK1795K2	6PK1795	V85592	V85519
6PK1870K1	6PK1870	V85597	V85529
6PK1873K1	6PK1873	V85603	V85523
6PK1873K3	6PK1873	V85558	V85522
6PK1873K4	6PK1873	V85550 V85517 V85605	
6PK1900K1	6PK1900	V85544	
6PK1950K1	6PK1950	V85703 V85701	V85702
6PK2080K1	6PK2080	V85593 V85594	V85527
6PK2260K1	6PK2260	V85575	V85540
6PK2260K2	6PK2260	V85575	V85540
6PK2271K1	6PK2271	V85575	V85540
6PK2404K1	6PK2404	V85532 V85606	V85539 V85540
<b>7PK</b>			
7PK1035K1	7PK1035	V85707	
7PK1125K1	7PK1125	V85577	
7PK1795K1	7PK1795	V85584	V85512
7PK1970K1	7PK1970	V85709	V85708

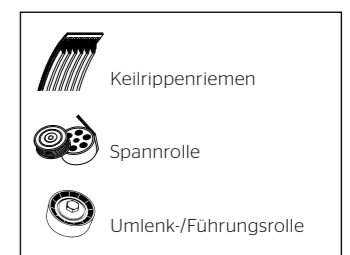



# ContiTech

## Power Transmission Group

### Markt Segment

Automotive Aftermarket

### Kontakt

ContiTech Antriebssysteme GmbH  
Philipsbornstraße 1  
Hannover, Deutschland  
Techn. Hotline +49 (0)511 938 - 5178  
aam@ptg.contitech.de

Ihr Ansprechpartner vor Ort  
[www.contitech.de/contactlocator](http://www.contitech.de/contactlocator)



Daten, Anleitungen oder weitere technische Informationen im PIC unter [www.contitech.de/pic](http://www.contitech.de/pic) oder einfach QR-Code scannen.

### Zertifiziert nach



## ContiTech. Engineering Next Level

ContiTech ist als Division des Continental Konzerns anerkannter Innovations- und Technologieführer für Kautschuk- und Kunststoffprodukte. Als zukunftsfähiger Partner der Industrie schaffen wir rund um den Globus Lösungen mit unseren und für unsere Kunden: marktgerecht und individuell. Mit unserer umfassenden Material- und Verfahrenskompetenz sind wir in der Lage, Spitzentechnologien zu entwickeln. Dabei haben wir den verantwortungsvollen Umgang mit Ressourcen stets im Blick. Wir adaptieren früh wesentliche technologische Trends wie Funktionsintegration, Leichtbau oder Reduzierung von Komplexität. Dafür halten wir bereits heute eine Vielzahl von Produkten und Dienstleistungen bereit, damit wir schon da sind, wenn Sie uns brauchen.